



STORAGE
AND
KENNELS



SUMMERHOUSES

SHEDS



PLAYHOUSES



introduction

At TGB Sheds we manufacture a comprehensive range of quality garden buildings. We take great care and pride in our attention to detail and feel confident you will find a product suitable for your needs. Many options are available for all our buildings, these include; 22mm floorboards, 22mm premier cladding, 19mm log effect cladding, security products, 38mm x 50mm framing as standard, 50mm x 50mm and 50mm x 75mm framing, pressure treated tanalised timber, additional doors and windows, and increased eaves heights. If you cannot find a building to suit your needs please enquire about a custom built model as we cater for our customer needs.

We are a progressive forward thinking company and in-line with our policy of continual development and improvement reserve the right to change specifications, designs and prices without notice.

All buildings are pre-treated with quality water based wood preservative prior to delivery.* To ensure longevity we recommend a top coat upon installation, and annually thereafter. Timber is a natural product, subject to changes caused by environmental conditions, to minimise contraction and expansion it is essential to maintain your building.

All timber sizes are nominal, before machining unless stated.

All building dimensions shown are approximate, based on external wall sizes, allowances should be made for roof overhangs when locating your building in a confined space.

All glass used is 3mm horticultural unless otherwise stated.



Specifications of timber used. All sizes are nominal (before machining) unless otherwise stated.

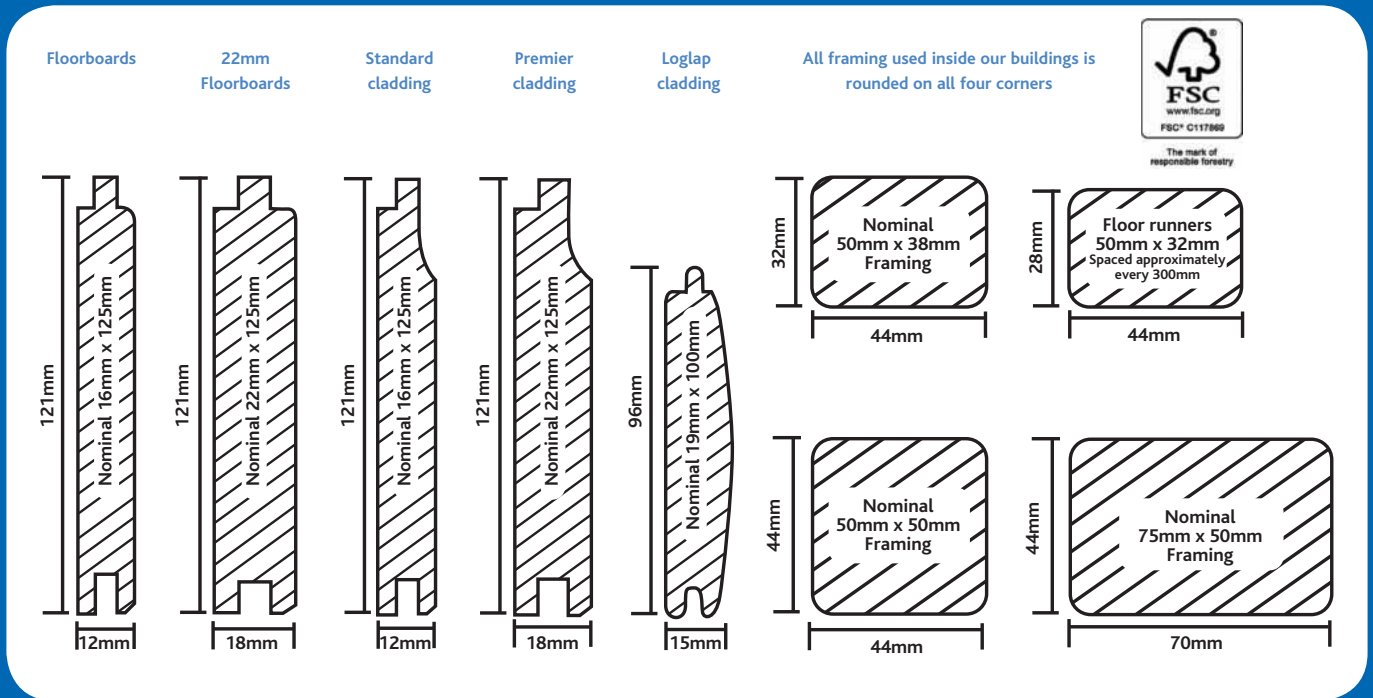

The finished sizes of our product are accurate to +/- 1mm.

PLEASE NOTE:

Buildings are available in all timber specifications and can be manufactured to your individual requirements. All measurements in the brochure are internal eaves and ridge height and for planning application purposes, the external measurements including roof and floor joists will be required.

We now offer pressure treated timber as an upgrade - Tanalised E - on all our products

Specifications of pressure treated timber used. All sizes are nominal (before machining) unless otherwise stated.

Main Features

- All pressure treated buildings are manufactured using 15mm finished cladding with an extended 10mm tongue.
- Protected by a unique, highly developed preservative formulation, TANALISED E pressure treated timber gives a reliable and consistent protection against fungal decay and insect attack.
- Appealing natural pale green colour with excellent weathering properties.
- Usually specified for indoor and outdoor applications where there is a medium to high risk of fungal decay and insect attack, e.g. general construction, landscaping and leisure timbers, fencing and other outdoor timber projects.
- TANALISED E is tested in accordance with the requirements of BS EN599 and new European standards.
- TANALISED E is acknowledged globally on performance for long term protection against decay and insect attack

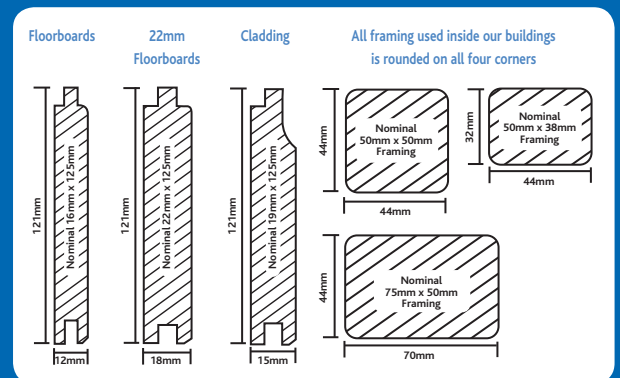





















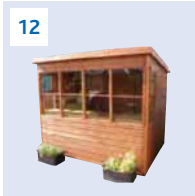











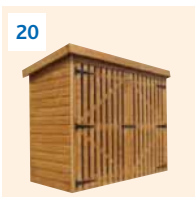

The finished sizes of our product are accurate to +/- 1mm.

Guarantee

- Minimum 15 year guarantee against general timber rot and decay - the guarantee does not cover against splits or movement which may occur naturally over time.
- All buildings must be installed correctly using manufacturers instructions and treated annually using correct water repellent preservative and all windows to be made water tight using silicone or sealant to maintain validity of the guarantee.

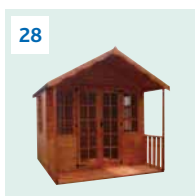

contents

sheds	5 	5 	6 	6 
7 	8 	9 	9 	10 
11 	12 	13 	13 	14 
14 	15 	16 	16 	17 
18 	storage & kennels	19 	19 	20 
20 	21 	21 	21 	22 
22 	23 	summer houses	24 	25 
26 	27 	28 	29 	30 

contents



- 5 Superior Apex
- 5 Standard Apex
- 6 Superior Pent
- 6 Standard Pent
- 7 Hipex
- 8 Cabin
- 9 Bentley Supreme Apex
- 9 Bentley Supreme Pent
- 10 Potting Shed
- 11 Combi-Potting Shed
- 12 Sunflower
- 13 Security Apex
- 13 Security Pent
- 14 Heavy Duty Apex
- 14 Heavy Duty Pent
- 15 Garage Apex and Pent
- 16 Rhino Apex

- 16 Rhino Pent
- 17 Groundsman
- 18 Corner Cabin
- 19 Garden Store
- 19 Garden Tidy
- 20 Garden Chest
- 20 Wheelie Bin Store
- 21 Dog Kennel
- 21 Animal Arc
- 21 Deluxe Apex Kennel and Run
- 22 Pent Kennel and Run
- 22 Hen House
- 23 Traditional Dutch Barn
- 24 Summer Cabin
- 25 Althorpe
- 26 Ascot
- 27 Balmoral

- 28 Chatsworth
- 29 Buckingham
- 30 Windsor
- 31 Kensington
- 32 Wentworth
- 33 The Elton Home Office
- 34 Corner Summer House Georgian
- 35 Corner Summer House Leaded
- 36 Hipped Roof Corner Summerhouse
- 37 Blenheim Corner Summerhouse
- 38 Pavilion
- 39 Pent Summer House
- 40 Dual Pent Summerhouse
- 41 Pent Summerhouse with Folding Doors
- 42 Sunningdale

- 43 The Sunroom
- 44 Octagonal Arbour
- 45 Octagen 8 + 10
- 46 Stretched Octagonal 8
- 47 Sandringham
- 48 Toddlers Retreat
- 49 My Little Den
- 50 Ladybird Cottage
- 51 Snowdrop Cottage
- 52 Mini Barn
- 53 Escape
- 54 Wilton Lodge
- 55 Candy Cabin
- 56 The Hideaway
- 57 Charleys Castle
- 58 Kids Club House

PLEASE NOTE: All our playhouses conform to trading standards BS5665 and are fitted with the CE mark
 Safety features include: acrylic safety glass with planed and rounded corners on all the framing, staircases with horizontal tread, and hand rails. Doors are fitted with anti trap plastic strip to prevent finger injury.



**SUPERIOR APEX
STANDARD FEATURES**

Fully tongue and grooved construction
 Door can be positioned on any side or end wall
 Ledged and braced door
 Lock and key
 Interchangeable panels

SPECIFICATION

Sizes from:
 1.22m x 1.22m (4' x 4') up to
 3.66m x 2.44m (12' x 8')
 Eaves Height 1864mm
 Ridge Height
 4' Front - 86" / 2190mm
 5' - 89" / 2260mm
 6' - 92" / 2336mm
 8' - 97" / 2475mm
 Door 1880mm x 762mm
 Windows 610mm x 457mm
 Framing 38mm x 50mm
 Cladding 16mm x 125mm

OPTIONS AVAILABLE

22mm premier cladding
 19mm Log Lap cladding
 22mm Heavy duty floor
 50mm x 50mm framing
 Security options
 Opening window
 Felt options
 Tanalised Timber

Superior &
Standard Apex

Superior Apex

Standard Apex



If Standard Apex door option B,C or D are chosen then the height of the door is reduced by 190mm to 1575mm x 762mm.

**STANDARD APEX
STANDARD FEATURES**

Fully tongue and grooved construction
 Ledged and braced door
 Lock and key
 Interchangeable panels

SPECIFICATION

Sizes from:
 1.22m x 1.22m (4' x 4') up to
 3.66m x 2.44m (12' x 8')
 Eaves height 1680mm
 Ridge height
 4' Front - 78" / 1985mm
 5' - 81" / 2050mm
 6' - 85" / 2160mm

8' - 90" / 2280mm
 Door 1765mm x 762mm
 Windows 610mm x 457mm
 Framing 38mm x 50mm
 Cladding 16mm x 125mm

OPTIONS AVAILABLE

22mm premier cladding
 19mm Log Lap cladding
 22mm Heavy duty floor
 50mm x 50mm framing
 security options
 opening window
 Stable Door
 Felt options
 Tanalised Timber

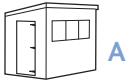

A



B

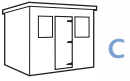

C

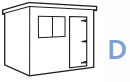

D

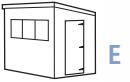

E



V



W



X



Y



Z



**SUPERIOR PENT
STANDARD FEATURES**

3" x 2" Framed roof
Fully tongue and grooved construction
Door can be positioned on any side or end wall
Lock and key

SPECIFICATION

Sizes from:
1.22m x 1.22m (4' x 4') to
3.66m x 2.44m (12' x 8')
Eaves height 1937mm
Ridge height 2153mm
Door 1880mm x 762mm
Windows 610mm x 457mm
Framing 38mm x 50mm
Cladding 16mm x 125mm

OPTIONS AVAILABLE

22mm premier cladding
19mm Log Lap cladding
22mm Heavy duty floor
50mm x 50mm framing
Security options
Felt options
Tanalised Timber

Superior &
Standard Pent

Superior Pent

Standard Pent



If Standard Pent door option W, X or Y are chosen then the height of the door will be reduced by 190mm to 1575mm x 762mm.

**STANDARD PENT
STANDARD FEATURES**

3" x 2" Roof
Fully tongue and grooved construction
Door can be positioned on any side or end wall
Lock and key

SPECIFICATION

Sizes from:
1.22m x 1.22m (4' x 4') to
3.66m x 2.44m (12' x 8')
Eaves height 68" / 1737mm
Ridge height 76" / 1953mm
Door (front) 1765mm x 762mm
Door (to 4ft end) 1690mm x 762mm

Windows 610mm x 457mm
Framing 38mm x 50mm
Cladding 16mm x 125mm

OPTIONS AVAILABLE

22mm premier cladding
19mm Log Lap cladding
22mm Heavy duty floor
50mm x 50mm framing
Security options
Felt options
Tanalised Timber



Hipex

STANDARD FEATURES

Fully tongued and grooved construction
 Door can be positioned on front or either end wall
 Ledged and braced door
 Lock and key

SPECIFICATION

Sizes from 2.44m x 1.83m (8' x 6') up to 3.66m x 2.44m (12' x 8')
 Eaves height at front 1964mm
 Eaves height at back 1780mm
 Ridge height
 4' Front – 90" / 2290mm
 5' – 93" / 2360mm

6' – 96" / 2436mm
 8' – 101" / 2575mm
 Door 1765mm x 762mm
 Windows 610mm x 457mm
 Framing 38mm x 50mm
 Cladding 16mm x 125mm

OPTIONS AVAILABLE

50mm x 50mm framing
 22mm Premier Cladding
 19mm Log Lap Cladding
 22mm Heavy duty floor
 Security options
 Stable door
 Felt options
 Tanalised Timber



Cabin

STANDARD FEATURES

Front and side fixed windows
 Roof overhang 1/305mm
 Central door
 Lock and key
 Fully tongue and groove construction

SPECIFICATION

Sizes from:
 1.52m x 2.13m (5' x 7') up to
 2.44m x 3.05m (8' x 10')
 Eaves height 1680mm
 Ridge height 6' Front - 85" / 2160mm
 7' - 89" / 2270mm
 8' - 90" / 2280mm
 10' - 93" / 2370mm

Door 1765mm x 762mm
 Windows 610mm x 457mm
 Framing 38mm x 50mm
 Cladding 16mm x 125mm

OPTIONS AVAILABLE

50mm x 50mm framing
 22mm premier cladding
 19mm Log Lap cladding
 22mm Heavy duty floor
 2'6" or 4' verandah
 Security options
 Stable door
 Felt options
 Tanalised Timber



Bentley's Supreme Apex and Pent

PENT



STANDARD FEATURES

Diagonal bracing in the sides
 Diagonal bracing in the ends
 38mm x 50mm boxed framed door
 6'2" High door (available in either end)
 Standard press lock and key
 Zinc plated hinges
 3 fixed windows

APEX SPECIFICATION

Sizes from 2.44m x 1.83m (8' x 6') up
 to 3.66m x 2.44m (12' x 8')
 Eaves height 70" / 1778mm
 Ridge height 4' Front – 81" / 2078mm
 5' – 84" / 2143mm
 6' – 88" / 2253mm
 8' – 93" / 2373mm
 Door 1778mm x 914mm
 Windows 610mm x 457mm

Framing 38mm x 50mm
 Cladding 16mm x 125mm

PENT SPECIFICATION

Eaves height 1937mm
 Ridge height 2153mm

OPTIONS AVAILABLE

22mm Premier Cladding
 19mm Log Lap Cladding
 22mm Heavy duty floor
 Increased height options which
 enables the door to be positioned on
 any side wall
 Workshop upgrade to include 4' wide
 fully framed boxed door
 Felt options
 Tanalised Timber

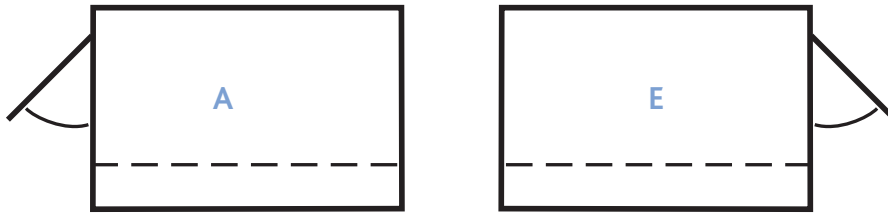

Potting Shed

STANDARD FEATURES

3" x 2" Framed roof
 Full length slatted staging under window
 Stable door
 Opening window in one end
 Lock and key

SPECIFICATION

Sizes from:
 1.83m x 1.83m (6' x 6') to
 3.05m x 2.44m (10' x 8')
 Eaves height 73" / 1854mm
 Ridge height 81" / 2058mm
 Door 1765mm x 762mm

Windows 6' - 1530 x 1200mm
 8' - 2160mm x 1200mm
 10' - 2750mm x 1200mm
 Framing 38mm x 50mm
 Cladding 16mm x 125mm

OPTIONS AVAILABLE

Toughened glass
 22mm premier cladding
 50mm x 50mm Framing
 22mm Heavy duty floor
 Door available at either end of building
 Felt options
 Tanalised Timber

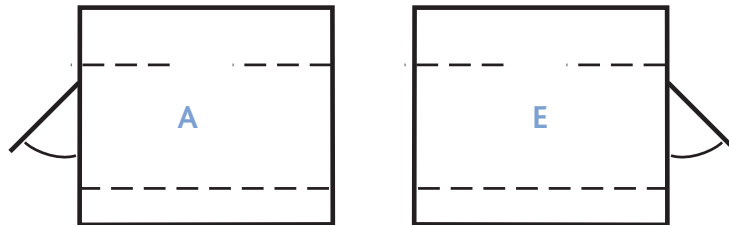

Combi-Potting Shed



Internal sliding door

STANDARD FEATURES

- 3" x 2" Framed roof
- Full length slatted staging under window
- Stable door
- Opening window in one end
- Integrated 4ft wide storage room with access via internal sliding door
- 2 - 4ft parallel shelves in storage room
- Profiled fascias

SPECIFICATION

- Sizes from 2.44m x 3.05m (8' x 10') to 3.66m x 3.66m (12' x 12')
- Eaves height 2112mm / 83"
- Ridge height 2307mm / 91"
- Stable door 1765mm x 762mm

- Internal sliding door 1810mm x 762mm
- Windows 6' - 1530mm x 1200mm / 8' - 2160mm x 1200mm / 10' - 2750mm x 1200mm
- Framing 50mm x 50mm
- Cladding 16mm x 125mm

OPTIONS AVAILABLE

- Toughened glass
- 22mm Premier cladding
- Framing 75mm x 50mm
- 22mm Heavy duty floor
- Door available at either end
- Felt options
- Tanalised Timber

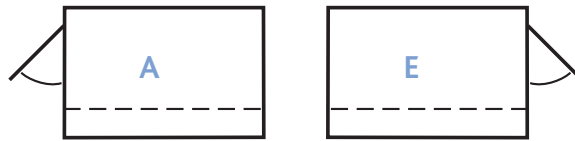

Sunflower

STANDARD FEATURES

- 3" x 2" Framed roof
- Full length slatted staging under window
- Full height windows returning at both ends
- Two joinery opening windows
- Lock and Key

SPECIFICATION

- Sizes from:
- 1.83m x 1.83m (6' x 6') to
- 3.05m x 2.44m (10' x 8')
- Eaves height 73" / 1860mm
- Ridge height 81" / 2057mm

- Door 1765mm x 762mm
- Windows 6' - 1645mm x 905mm
- 8' - 2220mm x 905mm
- 10' - 2805mm x 905mm
- Framing 38mm x 50mm
- Cladding 16mm x 125mm

OPTIONS AVAILABLE

- 22mm premier cladding
- 22mm Heavy duty floor
- 50mm x 50mm framing
- Stable door
- Door available at either end of building
- Felt options
- Tanalised Timber

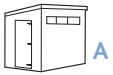

A



B

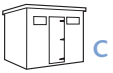

C

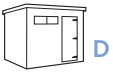

D

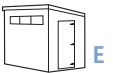

E



V



W



X



Y



Z



A



B



C



D



E

Security Apex and Pent

PENT



STANDARD FEATURES

Framing at 1'-300mm intervals throughout the sides for increased strength
 38mm x 50mm diagonal bracing in gable ends
 Galvanised bolted hinges
 Security bolted padbolt protector
 Internal glazed security window

APEX SPECIFICATION

Sizes from:
 1.22m x 1.22m (4' x 4') to
 3.66m x 2.44m (12' x 8')
 Eaves height apex 1864mm
 Ridge height apex 6' Front - 92" / 2350mm
 8' - 97" / 2475mm
 Door 1880mm x 762mm

Windows 1220mm x 150mm
 Framing 38mm x 50mm
 Door fully framed and braced in 50mm x 50mm framing
 Cladding 16mm x 125mm

PENT SPECIFICATION

Eaves ht 76" / 1937mm
 Ridge ht 84" / 2153mm

OPTIONS AVAILABLE

50mm x 50mm framing
 22mm premier cladding
 Felt options
 Tanalised Timber
 Loglap cladding

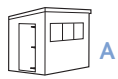

A

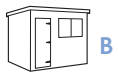

B

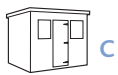

C



D

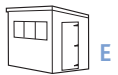

E

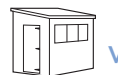

V



W



X



Y



Z



A



B



C



D



E

Please note: this model is shown with the 4ft double doors upgrade



Heavy Duty Apex and Pent

PENT



Please note: this model is shown with the 4ft double doors upgrade

STANDARD FEATURES

50mm x 50mm framing throughout with diagonal bracing
Substantial 75mm x 50mm roof truss: (as pictured)
1 up to 15ft
3 up to 20ft
5 up to 30ft
Heavy duty roofing felt
Joinery windows

APEX SPECIFICATION

Sizes from:
3.05m x 2.44m (10' x 8') to
9.14m x 3.66m (30' x 12')
Eaves height 1895mm
Ridge height 8' Front - 98" / 2490mm
10' - 102" / 2595mm
12' - 106" / 2690mm

Door 1880mm x 762mm
Windows 610mm x 457mm
Opening window 552mm x 400mm
Framing 50mm x 50mm
Cladding 16mm x 125mm

PENT SPECIFICATION

Eaves height 76" / 1937mm
Eaves height 84" / 2153mm
Door 1880mm x 762mm

OPTIONS AVAILABLE

22mm premier cladding
22mm Heavy duty floor
4', 5', 6' or 7' double doors
Security options
Felt options
Tanalised Timber



Garage



Pent Garage available on request

STANDARD FEATURES

50mm x 50mm framing throughout with diagonal side bracing
 Substantial 75mm x 50mm roof truss: (as pictured)
 1 up to 15ft
 3 up to 20ft
 5 up to 30ft
 Heavy duty roofing felt
 Joinery windows
 No floor

SPECIFICATION

Sizes from:
 3.05m x 2.44m (10' x 8') to
 9.14m x 3.66m (30' x 12')
 Eaves height 74" / 1895mm
 Ridge height 8' Front - 94" / 2490mm
 10' - 102" / 2595mm

12' - 106" / 2690mm
 Double Doors 1880mm x 2135mm
 Side Door 1775mm x 762mm
 All doors are in 75mm x 50mm framing and braced
 Windows 610mm x 457mm
 Opening window 552mm x 400mm
 Framing 50mm x 50mm
 Cladding 16mm x 125mm

OPTIONS AVAILABLE

22mm premier cladding
 4', 5', 6' or 7' fully framed 75mm x 50mm double doors
 With lock and key
 Security options
 Felt options
 Tanalised Timber



Rhino Apex and Pent



STANDARD FEATURES

- 75mm x 50mm Fully framed door
- Roof constructed of 75mm x 50mm framing
- Door can be positioned at any side or end wall
- Mortice lock and key with antique handles
- 30" fully framed boxed door and fully boarded both sides
- Heavy duty hinges
- 75mm x 50mm framed roofing truss
- 3 fixed windows
- Heavy duty felt

APEX SPECIFICATION

- Sizes from 2.44m x 1.83m (8' x 6') up to 3.66m x 2.44m (12' x 8')
- Eaves height 1.864m
- Ridge height

4' Front – 86" / 2190mm

5' – 89" / 2260mm

6' – 92" / 2336mm

8' – 97" / 2475mm

Door 1880mm x 762mm

Windows 610mm x 457mm

Framing 75mm x 50mm

Cladding 16mm x 125mm

PENT SPECIFICATION

Eaves height 76" / 1937mm

Ridge height 85" / 2153mm

OPTIONS AVAILABLE

- 22mm Premier Cladding
- 19mm Log Lap Cladding
- 22mm Heavy duty floor
- Felt options
- Tanalised Timber



The Groundsman

STANDARD FEATURES

4ft double doors boarded both sides,
75mm x 50mm fully framed
Roof constructed of 75mm x 50mm
framing
Doors can be positioned on any side
or end wall
Diagonal bracing to sides and ends
(as pictured)
Mortice lock and key with antique
handles
Heavy duty hinges
75mm x 50mm Framed roof truss
(as pictured)
Joinery windows
Untreated workbench (h) 825mm x
(w) 1650mm x (d) 635mm (as pictured)
Heavy duty felt

APEX SPECIFICATION

Sizes from 2.44m x 1.83m (8' x 6') up

to 3.66m x 2.44m (12' x 8')

Eaves height 1.864m
Ridge height:
4' Front – 86" / 2190mm
5' – 89" / 2260mm
6' – 92" / 2336mm
8' – 97" / 2475mm
Door 1880mm x 1220mm
2 fixed windows 610mm x 457mm
1 opening window 552mm x 400mm
Framing 75mm x 50mm
Cladding 16mm x 125mm

PENT SPECIFICATION

Eaves height 76" / 1937mm
Ridge height 85" / 2153mm

OPTIONS AVAILABLE

22mm Premier Cladding
19mm Log Lap Cladding
22mm Heavy duty floor
Felt options
Tanalised Timber



Untreated workbench

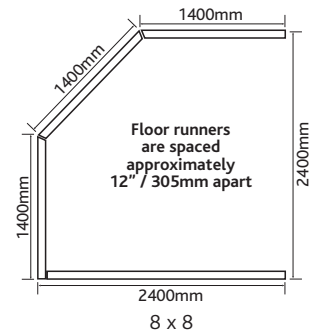
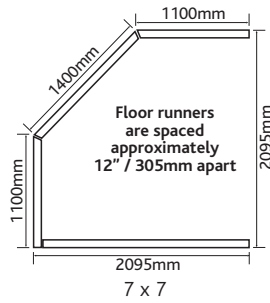
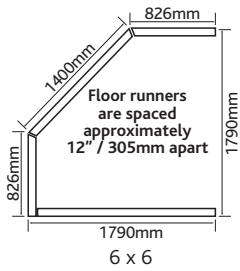

Corner Cabin

STANDARD FEATURES

3' wide door ledged and braced
 50mm x 50mm door with rim lock,
 door knob and 16" zinc coated door
 hinges
 Joinery opening windows

SPECIFICATION

Eaves height 76" / 1937mm
 Ridge height 84" / 2153mm
 Door 1880mm x 914mm
 Windows 610mm x 457mm
 Framing 38mm x 50mm

OPTIONS AVAILABLE

22mm Premier cladding
 22mm Heavy duty floor
 50mm x 50mm framing
 Felt options
 Tanalised Timber

Garden Store



STANDARD FEATURES

2' 6" Door
Fully tongue and groove construction
Door position on any side or end wall
Lock and key
Ledged and brace door

SPECIFICATION

Size: 1.52m x 915mm (5'x3')
Eaves height 1610mm
Ridge height 1710mm
Door 1460mm x 762mm
Framing 38mm x 50mm
Cladding 16mm x 125mm

OPTIONS AVAILABLE

Doors available in any position
22mm Premier cladding
22mm floor boards
Tanalised Timber
Loglap Cladding
Felt options

Garden Tidy



STANDARD FEATURES

4' double door
Fully tongue and groove construction
Lock and key
Ledged and brace doors
Roof can slope either way

SPECIFICATION

Size: 1.83m x 762mm (6' x 2'6")
Eaves height 1610mm
Ridge height 1710mm
Double doors 1460mm x 1320mm
Framing 38mm x 50mm
Cladding 16mm x 125mm

OPTIONS AVAILABLE

22mm Premier cladding
22mm floor boards
Tanalised Timber
Loglap Cladding
Felt options

Garden Chest



STANDARD FEATURES

Hinged lid with hasp and staple
Sliding internal storage shelf

SPECIFICATION

Size: 1.52m x 610mm (5' x 2')
Eaves height 710mm
Ridge height 802mm
Framing 38mm x 50mm
Cladding 16mm x 125mm
Tanalised Timber

OPTIONS AVAILABLE

22mm Premier cladding
22mm floor boards
Tanalised Timber
Loglap Cladding
Felt options

Wheellie Bin Store



STANDARD FEATURES

Tower bolt fitted to each door
Roof can slope either way
Slatted doors to allow for ventilation
No floor

SPECIFICATION

Size: 2134mm x 915mm (7' x 3')
Eaves height 1555mm
Ridge height 1655mm
Slated Double Doors 1550mm x 937mm (x2)
Framing 38mm x 50mm
Cladding 16mm x 125mm (to sides and back)
Tower bolt fitted to each door

OPTIONS AVAILABLE

22mm Premier cladding
22mm floor boards
Tanalised Timber
Loglap Cladding
Felt options

Dog Kennel



SPECIFICATION

sizes: 1.22m x 915mm
(4' x 3')
1.22m x 1.22m (4' x 4')
Eaves height 660mm
Ridge height 940mm

hole size 380mm x 305mm
framing 38mm x 50mm
cladding 16mm x 125mm

Animal Arc



SPECIFICATION

2 Sliding hatches, one at
either end
4' x 3' 5" (at base) Run
with 13mm x 13mm
galvanised wire mesh
2'4 x 3' 5" (at base) Hut

with access hole
Size 1930mm x 1041mm
(6'4" x 3'5")
Ridge 1016mm / 40"
Doors 254mm x 279mm
Internal access hole height
190mm

Deluxe Apex Kennel



STANDARD FEATURES

4' x 6' kennel unit with floor
and access door with closing
bob hole
6' x 6' run with 50mm x 50mm
Galvanised weldmesh on
50mm x 50mm framing, with front
Access door
Run designed with bottom drainage
for easy cleaning

SPECIFICATION

Size: 3.05m x 1.83m (10' x 6')
Eaves height kennel 1780mm
Eaves height run 1832mm
Ridge height kennel 2250mm
Ridge height run 2305mm
Door in run 1757mm x 600mm
Door in kennel 1765mm x 604mm
Framing 50mm x 50mm
Cladding 16mm x 125mm

OPTIONS AVAILABLE

22mm premier cladding
19mm Log Lap cladding
22mm floorboards
Tanalised Timber
Felt Options

Pent Kennel & Run



STANDARD FEATURES

4' x 4' kennel with floor, front door and side with tower bolt

Dog access hole

Run made from 50mm x 50mm galvanized heavy duty wire mesh, on 50mm x 50mm framing,

Door with tower bolt

SPECIFICATION

Sizes: 3.05m x 1.22m (10' x 4') and 3.66m x 1.22m (12' x 4')

Eaves height 1433mm

Ridge height 1610mm

Doors 1455mm x 596mm

Framing kennel 38mm x 50mm

Framing run 38mm x 50mm and 50mm x 50mm

Cladding 16mm x 125mm

OPTIONS AVAILABLE

22mm premier cladding

19mm Log Lap cladding

22mm floorboards

Run on left side opposite to main picture

6' or 8' run

Tanalised Timber

Felt Options



Hen access door and ramp

Hen House



STANDARD FEATURES

3' X 6' Hen house with raised floor and single door. Separate closing hen access door and ramp

3' x 6' run with 13mm x 13mm

Galvanised weldmesh, and meshed door

SPECIFICATION

Size: 1.83m x 1.83m (6' x 6')

Eaves height 69¹/₄" / 1760mm

Ridge height 87³/₄" / 2230mm

Meshed door 610mm x 1760mm

Single door in Hen house 1460mm x 915mm

Hen house access door 485mm x 380mm

Ramp 315 x 750

Framing 50mm x 50mm

Cladding 16mm x 125mm

OPTIONS AVAILABLE

Attachable Nesting Box:

Size: 480mm x 1830mm (19" x 6")

Comprising of 3 nesting compartments each 585 mm x 355mm

Eaves height 31¹/₂" / 800mm

Ridge height 36¹/₂" / 927mm

22mm Premier cladding

19mm Log lap

22mm floorboards

Tanalised Timber

Felt Options



This model is shown with the coloured felt tiles upgrade

Traditional Dutch Barn

STANDARD FEATURES

Fully framed & braced 5ft barn style double doors
Door knob handle
Rim lock & key
One fixed window above door
Galvanised hinges
16mm x 125mm shiplap cladding
50mm x 50mm framing
1 internal shelf 33" wide
Green mineral felt (not shown in picture)
18' x 18" toughened glass

SPECIFICATION

Sizes available from 8ft x 6ft to 30ft x 10ft
Eaves height on all sizes 1680mm / 66"
Ridge height 6ft Front - 2605mm / 102"
Ridge height 8ft - 2980mm / 117"
Ridge height 10ft - 3355mm / 132"
Door size 5ft double doors barn

style with 22mm tongue & grooved cladding
Fixed Georgian window size 18" x 18" / 460mm x 460mm
Framing 50mm x 50mm
Cladding 16mm x 125mm

OPTIONS AVAILABLE

Framing 75mm x 50mm
22mm Premier cladding (as shown in picture)
19mm Log lap
22mm heavy duty floor boards
Felt options including tiles (as shown in picture)
Joinery opening side windows
Additional fixed window in the rear apex
Security option on door
Additional shelving
Tanalised Timber



Internal roof and shelf



Summer Cabin

STANDARD FEATURES

Roof overhang 1' / 305mm
Four diamond leaded windows
Stable door with ornate antique hinges
Rim lock and knob handle
Profiled fascia boards

SPECIFICATION

Sizes from: 1.52m x 2.13m (5' x 7') to
2.44m x 3.05m (8' x 10')
Eaves height 66" / 1680mm
Ridge height 6' Front - 85" / 2160mm
7' - 89" / 2270mm
8' - 90" / 2280mm
10' - 93" / 2370mm
Door 1765mm x 762mm

Windows 610mm x 457mm

Framing: Up to 10' Front - 38mm x
50mm

12' and Over - 50mm x 50mm

Cladding 16mm x 125mm

OPTIONS AVAILABLE

22mm premier cladding

19mm Log Lap Cladding

22mm floor boards

Veranda 2'6" or 4'

50mm x 50mm framing

Square leaded windows

Toughened glass

Felt options

Tanalised Timber



The Althorpe

STANDARD FEATURES

Half Glazed arched top doors with antique hinges, ornate handle and lever lock
2 Arched top front fixed windows
Door Drip
Roof overhang 1' / 305mm

SPECIFICATION

Sizes: 1.52m x 2.13m (5x7) and 2.13m x 2.13m (7x7) only
Eaves height 73" / 1864mm
Ridge height 91" / 2312mm
Door 1790mm x 1103mm
Windows 445mm x 1010mm
Framing: Up to 10' Front - 38mm x 50mm

12' and Over - 50mm x 50mm
Cladding 16mm x 125mm

OPTIONS AVAILABLE

22mm Premier Cladding
19mm Log Lap cladding
22mm Heavy Duty Floor Boards
2'6" or 4' Veranda
Side window fixed or opening
Square or diamond leaded windows
Felt options
Tanalised Timber



The Ascot

STANDARD FEATURES

Fully glazed plain glass double doors with antique hinges, ornate handle and lever lock

2 front fixed plain full length windows

2 side fixed plain full length windows

Roof overhang 1' / 305mm

Door drip

Profiled fascia boards

SPECIFICATION

Sizes from 1.83m x 2.44m (6'x8') to 3.66m x 3.66 (12' x 12')

Eaves height 72" / 1838mm

Ridge height 8' Front – 97" / 2466mm,

10' – 102" / 2580mm,

12' – 106" / 2700mm

Doors 1790mm x 1103mm

Windows 1622mm x 452mm

Framing: Up to 10' Front - 38mm x 50mm

12' and Over - 50mm x 50mm

Cladding 16mm x 125mm

OPTIONS AVAILABLE

Opening windows

22mm Premier cladding

19mm Log lap

22mm Floor boards

Toughened glass

50mm x 50mm Framing

2'6" or 4' Veranda



The Balmoral

STANDARD FEATURES

Half glazed joinery doors, with antique hinges, ornate handle and lever lock

4 front fixed windows

Roof overhang 1' / 305mm

Profiled fascia boards

Door drip

SPECIFICATION

Sizes from: 1.83m x 2.44m (6' x 8')
to 3.66m x 3.66m (12' x 12')

Eaves height 73" / 1864mm

Ridge height 8' Front / 98" / 2490mm

10' - 101" / 2570mm

12' - 104" / 2655mm

Double doors 1790mm x 1103mm

Windows: 7' Front 455mm x 403mm

8' 553mm x 400mm

10' and over 610 x 457mm

Framing: Up to 10' Front - 38mm x 50mm

12' and Over - 50mm x 50mm

Cladding 16mm x 125mm

OPTIONS AVAILABLE

22mm premier cladding

19mm Log Lap Cladding

22mm floor boards

Toughened glass

50mm x 50mm framing

2' 6" or 4' veranda

Felt options

Tanalised Timber



The Chatsworth

STANDARD FEATURES

Fully glazed Georgian double doors with antique hinges, ornate handle and lever lock

2 front fixed Georgian windows, if building is a 10ft front the 2 fixed windows become opening windows as standard

2 top hung opening

Georgian side windows

Roof overhang 1' / 305mm

Door drip

Profiled fascia boards

SPECIFICATION

Sizes from: 1.83m x 2.44m (6' x 8') to 3.66m x 3.66m (12' x 12')

Eaves height 73" / 1864mm

Ridge height 8' Front - 97" / 2466mm

10' - 102" / 2580mm

12' - 106" / 2700mm

Doors 1790mm x 1103mm

Windows 1010mm x 475mm

1040mm x 717mm

Framing: Up to 10' Front -

38mm x 50mm

12' and Over - 50mm x 50mm

Cladding 16mm x 125mm

OPTIONS AVAILABLE

22mm premier cladding

19mm Log Lap Cladding

22mm floor boards

Toughened glass

50mm x 50mm framing

2'6" or 4' veranda

Felt options

Tanalised Timber



The Buckingham

STANDARD FEATURES

Fully glazed georgian door with antique hinges, ornate handle and lever lock

Georgian bay window

1 Georgian top hung opening side window

Roof overhang 1' / 305mm

Profiled fascias

Door drip

SPECIFICATION

Sizes from: 1.83m x 1.83m (6' x 8') to 3.66m x 3.66m (12' x 12')

Eaves height 73" / 1864mm

Ridge height 8' Front - 98" / 2490mm

10' - 101" / 2570mm

12' - 104" / 2655mm

Door 1790mm x 762mm

Windows 1040mm x 717mm

Bay window 1035mm x 1035mm

Framing: Up to 10' Front - 38mm x 50mm

12' and Over - 50mm x 50mm

Cladding 16mm x 125mm

OPTIONS AVAILABLE

22mm premier cladding

22mm floor boards

Toughened glass

50mm x 50mm framing

19mm Loglap Cladding

2'6" or 4' veranda

Mirror image available

Felt options

Tanalised Timber



The Windsor

STANDARD FEATURES

Fully glazed georgian double doors, antique hinges, ornate handle and lever lock

Georgian bay window

2 Georgian top hung opening side windows

Roof overhang 1' / 305mm

Side wings 305mm

Profiled fascias

Door drip

SPECIFICATION

Sizes from: 1.83m x 3.05m (6' x 10') to 3.66m x 3.66m (12' x 12')

Eaves height 73" / 1864mm

Ridge height 10' Front - 101" / 2570mm

12' - 104" / 2655mm

Double doors 1790mm x 1103mm

Windows 1040mm x 717mm

Bay window 1035mm x 1035mm

Framing: Up to 10' Front -

38mm x 50mm

12' and Over - 50mm x 50mm

Cladding 16mm x 125mm

OPTIONS AVAILABLE

22mm premier cladding

19mm Log Lap Cladding

22mm floor boards

Toughened glass

50mm x 50mm framing

Mirror image available

Felt options

Tanalised Timber



This model is shown with the Loglap Cladding upgrade

The Kensington

STANDARD FEATURES

Fully glazed georgian double doors with antique hinges, ornate handle and lever lock
2 Georgian front windows
8ft front has 6 pane fixed
10ft / 12ft front has 9 pane openers
2 Georgian opening side windows
Roof overhang 1' / 305mm
Side wings 305mm
Profiled fascias
Door drip

SPECIFICATION

Sizes from: 1.83m x 3.05m (6' x 10') to 3.66m x 3.66m (12' x 12')
Eaves height 73" / 1864mm

Ridge height 8' Front - 98" / 2490mm
10' - 101" / 2570mm
12' - 104" / 2655mm
Double doors 1790mm x 1103mm
Windows 1040mm x 717mm
Framing: Up to 10' Front - 38mm x 50mm
12' and Over - 50mm x 50mm
Cladding 16mm x 125mm

OPTIONS AVAILABLE

22mm premier cladding
22mm floor boards
Toughened glass
50mm x 50mm framing
19mm Log Lap cladding
Felt options
Tanalised Timber



Wentworth

STANDARD FEATURES

Fully glazed georgian doors with antique hinges, ornate handle and lever lock
2 Georgian fixed front windows
2 top opening georgian side windows
4' veranda with plant boxes and side wings
Profiled fascia and veranda boards
Door drip

SPECIFICATION

Sizes from: 3.05m x 3.05m (10' x 10')
to 4.87m x 3.66m (16' x 12')
Eaves height 74" / 1891mm
Ridge height 10' Front - 101" /

2560mm
12' - 104" / 2645mm
Double doors 1790mm x 1510mm
Windows 1010mm x 475mm
1040mm x 717mm
Framing 50mm x 50mm
Cladding 16mm x 125mm

OPTIONS AVAILABLE

22mm premier cladding
19mm Log Lap Cladding
22mm floor boards
Toughened glass
Felt options
Tanalised Timber



The Elton Home Office

STANDARD FEATURES

Georgian half glazed door with arched inserts to accommodate double glazed units (not included)
Heavy duty bolted black door hinges
Door drip
Georgian opening windows with arched inserts to accommodate double glazed units (not included)
Roof overhang 1' / 305mm
75mm x 50mm framing to sides and ends and braced
Profiled fascias
Substantial 75mm x 50mm roof truss (as pictured):

SPECIFICATION

Sizes from: 2.44m x 3.05m (8' x 10')
to 4.87m x 3.66m (16' x 12')
Eaves height 82" / 2088mm

Ridge height 10' Front - 110" / 2790mm
12' - 113" / 2865mm
Door 1990mm x 762mm
Front window 1000mm x 1043mm
Side window 1413mm x 1043mm
Framing 75mm x 50mm
Cladding 16mm x 125mm

OPTIONS AVAILABLE

22mm premier cladding
19mm Log Lap cladding
22mm floorboards
Additional side window
Double glazing
Toughened glass
Felt options
Tanalised Timber

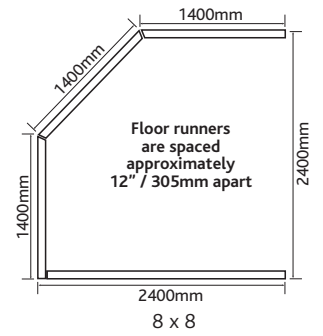
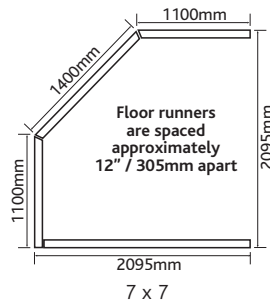
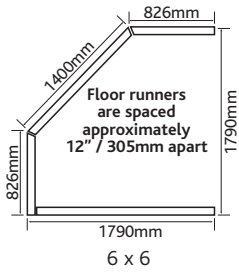

Corner Summerhouse Georgian

STANDARD FEATURES

Fully glazed Georgian double doors with antique hinges, ornate handle and lever lock

2 Georgian top opening side windows

Door drip

SPECIFICATION

Sizes from: 1.83m x 1.83m (6' x 6')

2.13m x 2.13m (7' x 7')

2.44m x 2.44m (8' x 8')

Eaves height 76" / 1942mm

Ridge height 84" / 2146mm

Double doors 1790mm x 1103mm

Windows 1040mm x 717mm

Framing 38mm x 50mm

Cladding 16mm x 125mm

OPTIONS AVAILABLE

22mm premier cladding

19mm Log Lap Cladding

22mm floor boards

Toughened glass

50mm x 50mm framing

Felt options

Tanalised Timber

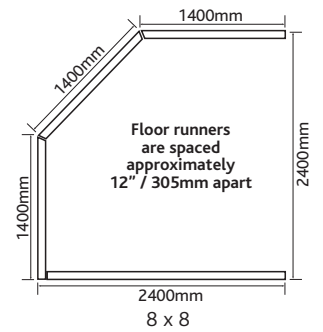
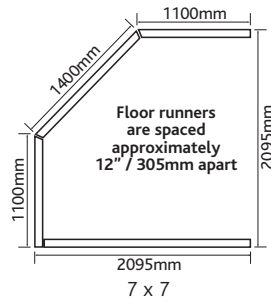
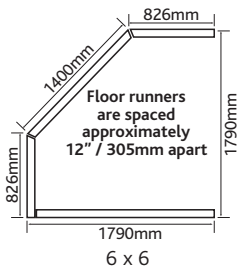

Corner Summerhouse Leaded

STANDARD FEATURES

Fully glazed double doors with leaded glass and antique hinges, ornate handle and lever lock

2 leaded glass top opening side windows

Door drip

SPECIFICATION

Sizes from: 1.83m x 1.83m (6' x 6')

2.13m x 2.13m (7' x 7')

2.44m x 2.44m (8' x 8')

Eaves height 76" / 1942mm

Ridge height 84" / 2146mm

Double doors 1790mm x 1103mm

Windows 1040mm x 717mm

Framing 38mm x 50mm

Cladding 16mm x 125mm

OPTIONS AVAILABLE

22mm cladding

19mm Log Lap Cladding

22mm floor boards

Toughened glass

50mm x 50mm framing

Felt options

Tanalised Timber

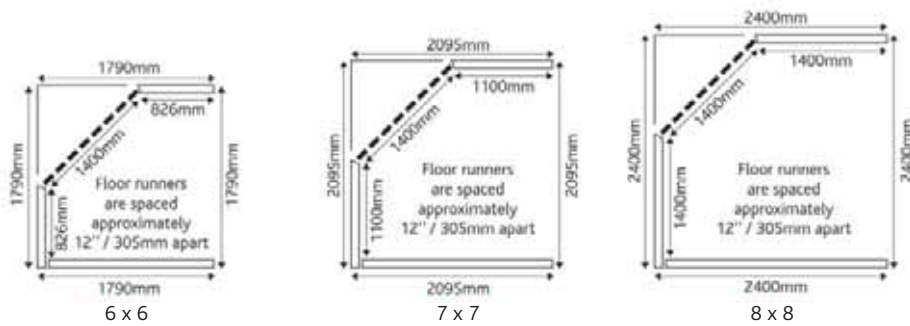

COLOURED TILE
OPTIONS



BLACK



RED



GREY



GREEN



Hipped Roof Corner Summerhouse



Internal roof structure

STANDARD FEATURES

- 2 opening side windows
- Double doors
- Antique style ironmongery
- Overhang over the door
- Plain fascia board
- Felt tiled hipped roof
- Decorative corner covers
- Finial and plinth

SPECIFICATION

- Sizes from (1.83m x 1.83M) 6ft x 6ft
- Eaves height 2130mm / 86"
- Ridge height on 6ft 3010mm / 120" (top of finial)
- Ridge height on 7ft 3120mm / 125" (top of finial)

- Ridge height on 8ft 3230mm / 130" (top of finial)
- Double doors 1790mm x 1103mm
- Windows 1040mm x 1717mm
- Framing 50mm x 38mm
- Cladding 16mm x 125mm
- Flooring 16mm x 125

OPTIONS AVAILABLE

- 22mm Premier cladding
- 19mm Log lap cladding
- 22mm heavy duty floor
- 50mm x 50mm framing
- 75mm x 50mm framing
- Choice of coloured felt tiles

summer houses

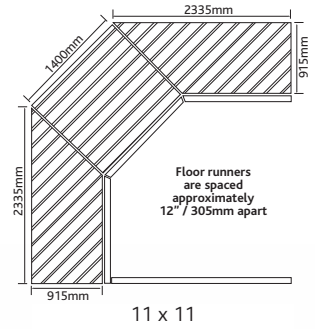
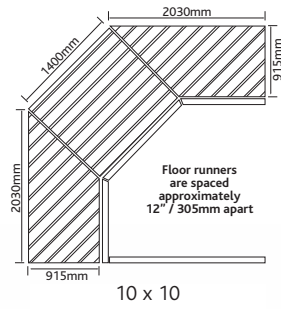
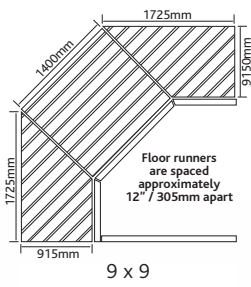

Blenheim Corner



Option available without upright supports

STANDARD FEATURES

- Fully glazed Georgian double doors
- Antique hinges
- Ornate handle with lever lock
- 2 top hung side windows
- Door drip
- Includes 3' veranda with roof overhang
- Roof is boarded on the underside of veranda

SPECIFICATION

- Sizes available from 9ft x 9ft to 11ft x 11ft including 3ft veranda
- Eaves height 76" / 1942
- Ridge height 95" / 2410
- Doors 1790mm x 1103mm

OPTIONS AVAILABLE

- 22mm cladding
- 19mm Log Lap Cladding
- 22mm floor boards
- Toughened glass
- 50mm x 50mm framing
- Felt options
- Tanalised Timber

COLOURED TILE
OPTIONS



BLACK

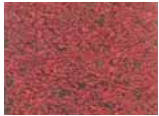

RED



GREY



GREEN



Pavilion

STANDARD FEATURES

Georgian double doors, antique hinges, ornate handle and lever lock

2 Georgian top hung 12 pane, opening side windows

2 front fixed Georgian windows

The front roof canopy is 485mm wide and tiled in red, green, black or slate tiles. The roof is felted with green roofing felt.

Profiled fascia boards

SPECIFICATION

Sizes from 2.44m x 1.83m (8x6) up to 3.05m x 2.44m (10x8)

Eaves height 77" / 1950mm

Ridge height 88" / 2170mm

Double doors 1790mm x 1103mm

Windows 1360mm x 718mm

Framing: up to 10' end 38mm x 50mm, 12' end and above 50mm x 50mm

Cladding 16mm x 125mm

OPTIONS AVAILABLE

22mm premier cladding

19mm Log Lap cladding

22mm Heavy Duty floor

Toughened Glass

50mm x 50mm framing

Felt options

Tanalised Timber



Pent Summerhouse

STANDARD FEATURES

Fully glazed Georgian double doors with antique hinges, ornate handle and lever lock

2 Georgian fixed front windows
2 Georgian 9 pane opening side windows

Profiled fascias
Door drip

SPECIFICATION

Sizes from: 1.52m x 2.44m (5' x 8') to 3.05m x 4.87m (10 x 16)

Eaves height 76" / 1937mm (back pent)
Ridge height 85" / 2153mm (front pent)
Double Doors 1790mm x 1103mm
Front windows 1010mm x 475mm

Side windows 1040mm x 717mm
Framing: up to 10' end 38mm x 50mm, 12' end and above 50mm x 50mm
Cladding 16mm x 125mm

OPTIONS AVAILABLE

22mm Premier cladding
19mm Log lap cladding
22mm Floor boards
50mm x 50mm framing
2'6" veranda with fully tiled canopy in a choice of red, slate, green or black tiles
Toughened Glass
Choice of Georgian, diamond lead, or square lead glazing
Tanalised Timber

COLOURED TILE
OPTIONS



BLACK

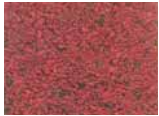

RED



GREY



GREEN



Dual Pent Summerhouse



STANDARD FEATURES

Half glazed arch top double doors with antique hinges, ornate handle and lever lock
 2 Arch top fixed front windows
 2 Arch top opening side windows
 Integrated 4' storage room with side access by security door
 Galvanised bolted hinges & padbolt protector to side access door
 Profiled fascias

SPECIFICATION

Sizes from: 1.83m x 2.44m (6' x 8') to 4.87m x 4.87m (16 x 16)
 Eaves height 76" / 1937mm
 Ridge height 85" / 2153mm
 Security door 1867mm x 908mm fully framed and braced in 50mm x 50mm framing
 Double Doors 1780mm x 1103mm

(10' & above)

1780mm x 1103mm (8')
 Front windows 445mm x 1010mm
 Side windows 1040mm x 717mm
 Framing: up to 10' end 38mm x 50mm, 12' end and above 50mm x 50mm
 Cladding 16mm x 125mm

OPTIONS AVAILABLE

22mm Premier cladding
 19mm Log lap cladding
 22mm Floor boards
 2'6" veranda with fully tiled canopy in a choice of red, slate, green or black tiles
 Toughened Glass
 Choice of Georgian, diamond lead, or square lead glazing
 Tanalised Timber
 Felt Options



Pent Summer House with Folding Doors

STANDARD FEATURES

Bi folding doors with 8ft front
and Tri folding doors with 10ft front
Toughened glass
Green mineral felt
Profiled fascias
Door Drip
2 fixed side windows

SPECIFICATION

Size from 1.52m x 2.44m (5ft x 8ft)
to 3.05m x 4.87m (10ft x 16ft)
Eaves height 1937mm / 76"
(back pent)
Ridge height 2153mm / 85"
(front pent)
Bi folding doors 2005mm x 2555mm

Tri folding doors 2555mm x 2555mm
Framing 75mm x 50mm
Cladding 16mm x 125mm

OPTIONS AVAILABLE

22mm Premier Cladding
19mm Log Lap Cladding
22mm Heavy duty floor
50mm x 50mm Framing
2'6" Veranda with fully tiled
canopy in a choice of red slate,
green or black felt tiles
Double glazed units
Choice of Georgian, diamond or
square leaded glazing
Felt options
Tanalised Timber



Sunningdale

STANDARD FEATURES

- 2 Fixed front windows
- 4 Fixed side windows
- Double doors
- Toughened glass throughout
- Antique style ironmongery
- 1ft (305mm) overhang on the pent roof
- Plain fascia board
- Standard mineral felt

SPECIFICATION

Framing: up to 10' end 38mm x 50mm,
12' end and above 50mm x 50mm
Sizes from (2.44m x 1.83M) 8ft x 6ft
Eaves height 1950mm / 77" (rear)
Ridge height 2170mm / 88" (front)

Roof overhang ridge 2220mm / 90"
Doors 1790mm x 1170mm
Windows front 1647mm x 515mm
Windows side 1647mm x 515mm
Framing 50mm x 38mm
Cladding 16mm x 125mm
Flooring 16mm x 125mm

OPTIONS AVAILABLE

- 22mm Premier cladding
- 19mm Log lap cladding
- 22mm Heavy duty floor
- 50mm x 50mm framing
- 75mm x 50mm framing
- Veranda
- Profiled fascia boards
- Tanalised Timber



The Sunroom

STANDARD FEATURES

- Diagonal bracing
- 2 Fixed front windows with 3" x 2" casements
- 4 Fixed side windows with 3" x 2" casements
- 2 opening windows in rear
- Double doors to accommodate double glazing as windows
- Toughened glass throughout
- Chrome ironmongery
- Decorative fascia board
- Door drips
- Window cills
- Heavy Duty Felt

SPECIFICATION

- Sizes from (3.18m x 2.44M)
- 10ft 5" x 8ft

- Eaves height 2030mm / 80" (rear)
- Ridge height 2220mm / 91" (front)
- Doors 1790mm x 1125mm
- Windows front 1740mm x 919mm
- Windows side 1740mm x 919mm
- Windows in rear 720mm x 405mm
- Framing 75mm x 50mm
- Cladding 22mm x 125mm
- Flooring 22mm x 125mm

OPTIONS AVAILABLE

- 19mm Log lap cladding
- Canopy plus veranda
- Double glazed units
- Tanalised Timber
- Felt Options





Octagonal Arbour



Internal roof structure

STANDARD FEATURES

16mm x 125mm shiplap cladding
50mm x 50mm angled
and then planed framing
1 internal seat
Red mineral felt

SPECIFICATION

Sizes available from 6ft x 6ft
to 10ft x 10ft
Eaves height on all sizes 2075mm/81"
Ridge height 6ft – 2490mm/98"
Ridge height 8ft – 2665mm /105"
Ridge height 10ft – 2840mm /112"

OPTIONS AVAILABLE

22mm Premier Cladding
19mm Log lap Cladding
22mm Heavy duty floor
3 choices of lattice design
Profiles fascia boards
Felt options
Tanalised Timber

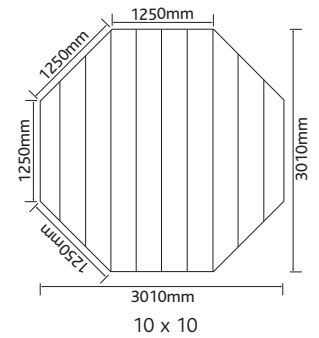
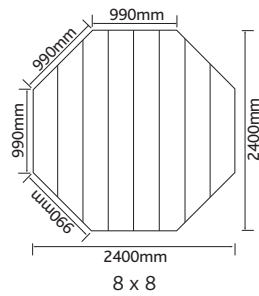

COLOURED TILE
OPTIONS



BLACK



RED



GREY



GREEN



Octagonal 8 and 10

STANDARD FEATURES

Half glazed joinery single door with antique hinges, ornate handle and lever lock

2 fully glazed top hung windows

2 fully glazed fixed windows

All side panels of the same size are fully interchangeable upon installation

Choice of tiled roof in red, slate, green or black

Door drip

Choice of georgian, diamond lead, or square lead glazing

SPECIFICATION

Size: 8' x 8' / 2440mm x 2440mm

Eaves height 80" / 2035mm

Ridge height 99" / 2535mm

Door 1790mm x 762mm

Windows 1040mm x 717mm

Framing 38mm x 50mm

Cladding 16mm x 125mm

OCTAGONAL 10 SPECIFICATION

size: 10' x 10' / 3050mm x 3050mm

Eaves height 80" / 2035mm

Ridge height 99" / 2535mm

Double doors 1790mm x 1103mm

OPTIONS AVAILABLE

22mm premier cladding

19mm Log Lap cladding

22mm Heavy duty floor

Toughened glass

Tanalised Timber

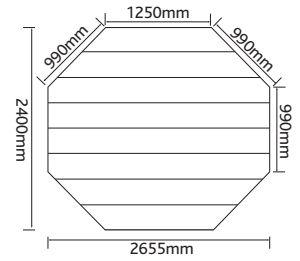

COLOURED TILE
OPTIONS



BLACK



RED



GREY



GREEN

Stretched Octagonal 8

STANDARD FEATURES

Half glazed double doors with antique hinges, ornate handle and lever lock
 2 fully glazed top hung windows
 2 fully glazed fixed windows
 Choice of tiled roof in red, slate, green or black
 Door drip
 Choice of Georgian, diamond lead, or square lead glazing

SPECIFICATION

size: 8' x 8'9" / 2440mm x 2667mm
 Eaves height 80" / 2035mm
 Ridge height 99" / 2535mm
 Door 1790mm x 1103mm
 Windows 1040mm x 717mm
 Framing 38mm x 50mm
 Cladding 16mm x 125mm

OPTIONS AVAILABLE

22mm premier cladding
 19mm Log Lap cladding
 22mm floorboards
 Toughened glass
 Tanalised Timber

COLOURED TILE
OPTIONS



BLACK



RED



GREY



GREEN



The Sandringham

STANDARD FEATURES

Georgian double doors to accommodate double glazing, antique hinges, ornate handle and lever lock
2 Side 12 pane Georgian top hung opening windows to accommodate double glazing

2 Front 12 pane Georgian fixed windows to accommodate double glazing

The hipped roof comes with a choice of coloured felt tiles (not fitted)

Heavy duty 3" x 2" framing throughout

Toughened glass

SPECIFICATION

Size 3.05m x 3.05 (10' x 10')

Eaves height 2160mm / 85"
Ridge height 3416mm / 136"
Double doors 1790mm x 1103mm
Windows 1360mm x 718mm
Framing 75mm x 50mm
Cladding 16m x 125mm

OPTIONS AVAILABLE

22mm Premier cladding
19mm Log lap cladding
22mm Heavy duty floor
Coloured felt tiles with choice of Red, Green, Slate and Black
Double glazed units
Door and window options, plain, leaded and folding
Tanalised Timber



Toddlers Retreat



STANDARD FEATURES

Two side windows with acrylic
Door window Square acrylic
Profiled fascias
Antique door handle and hinges with
adjustable door catch

SPECIFICATION

Size: 4' X 4' (1.2m x 1.2m)
Eaves height 42¹/₄" (1074mm)
Ridge height 54¹/₂" (1384mm)
Door 1074mm x 596mm
Side windows 457mm x 457mm
Door window 305mm x 305mm
Framing 38mm x 50mm
Cladding 16mm x 125mm

OPTIONS AVAILABLE

22mm Premier cladding
19mm Log lap
Window Box
2' veranda
Felt options
Tanalised Timber
50mm x 50mm Framing



My Little Den



STANDARD FEATURES

Door with diamond window, antique hinges and handle with adjustable door catch

2 acrylic Georgian windows

Roof overhang 1' / 305mm

Profiled fascias

SPECIFICATION

Sizes from: 1.22m x 1.83m (4' x 6') to 2.44m x 1.83m (8' x 6')

Eaves height 51" / 1318mm

Ridge height 73" / 1850mm

Door 1282mm x 596mm

Windows 457mm x 457mm

Framing 38mm x 50mm

Cladding 16mm x 125mm

OPTIONS AVAILABLE

22mm premier cladding

19mm Log Lap cladding

22mm floorboards

Window box

2' veranda (with or without) please specify

Additional fixed side window

Felt options

Tanalised Timber

50mm x 50mm Framing



Ladybird Cottage



STANDARD FEATURES

Georgian joinery door with antique hinges and handle, with adjustable door catch

4 acrylic Georgian windows

Roof overhang 1' / 305mm

Profiled fascia boards

SPECIFICATION

Sizes from: 1.52m x 2.13m (5' x 7') to 2.74m x 2.13m (7' x 7')

Eaves height 49" / 1255mm

Ridge height 70" / 1790mm

Door 1180mm x 535mm

Windows 457mm x 457mm

Framing 38mm x 50mm

Cladding 16mm x 125mm

OPTIONS AVAILABLE

22mm premier cladding

19mm Log Lap cladding

22mm floorboards

2' verandah (with or without) please specify

Felt options

Tanalised Timber

50mm x 50mm Framing



Snowdrop Cottage



STANDARD FEATURES

- Antique hinges and handle with adjustable door catch
- 4 acrylic Georgian windows
- Georgian joinery door with antique hinges and handle with adjustable door catch
- Chimney pot
- Hip roof
- Profiled fascia boards

SPECIFICATION

- Sizes: 1.83m x 1.22m (6' x 4') and 2.13m x 1.52m (7' x 5')
- Eaves height 51" / 1318mm
- Ridge height 4' - 63" / 1615mm

- 5' - 70" / 1790mm
- Door 1180mm x 535mm
- Windows 457mm x 457mm
- Framing 38mm x 50mm
- Cladding 16mm x 125mm

OPTIONS AVAILABLE

- 22mm premier cladding
- 19mm Log Lap cladding
- 22mm floorboards
- Felt options
- Tanalised Timber
- 50mm x 50mm Framing



Mini Barn



Internal combined seat, bed and cupboard

STANDARD FEATURES

- Garage style doors
- Windows in doors
- Internal cupboard
- Combined seat/bed
- Antique style ironmongery
- Anti-trap safety features
- Plain fascias
- Standard mineral felt

SPECIFICATION

- Eaves height 1520mm / 60"
- Ridge height 2187mm / 87"
- Cupboard/bed height 580mm / 23"
- Windows 250mm x 250mm / 10" x 10"
- Double doors 1220mm x 1520mm / 48" x 60"

- Framing 38mm x 50mm
- Cladding 16mm x 125mm
- Floor and roof 16mm x 125mm

OPTIONS AVAILABLE

- 22mm Premier cladding
- 19mm Log lap cladding
- 22mm ¾" flooring
- 50mm x 50mm framing
- 75mm x 50mm framing
- Felt Options
- Felt tiled roof (4 colour options)
- Profiled fascia boards
- Additional windows
- Tanalised Timber
- Painted options available



Escape

CE



STANDARD FEATURES

Full size door with 10" diamond window, antique hinges and handle
 Internal bunk bed with safety rail, ladder and hand rail (as pictured)
 1 Acrylic Georgian window
 1 Window box
 Profiled fascias

SPECIFICATION

Size 2.44m x 1.83m (8' x 6')
 Eaves height 1964mm / 77"
 Ridge height 2436 / 96"
 Door 1765mm x 762mm
 Window 457mm x 457mm
 Framing 38mm x 50mm
 Cladding 16mm x 125mm

OPTIONS AVAILABLE

22mm Premier cladding
 19mm Log lap cladding
 22mm Floor boards
 Additional side windows
 Mirror image available
 Felt options
 Tanalised Timber



Wilton Lodge



STANDARD FEATURES

Door with diamond window, antique hinges and handle, with adjustable catch

3 acrylic Georgian windows with large window box

Roof overhang 1' / 305mm

Internal bunk bed with safety rail, ladder and hand rail (as pictured)

Profiled fascias

SPECIFICATION

Sizes from: 1.52m x 2.13m (5' x 7') to 2.74m x 2.13m (9' x 7')

Eaves height 56" / 1435mm to 70" / 1785mm

Ridge height 93" / 2350mm

Door 1410mm x 596mm

Windows 457mm x 457mm

Framing 38mm x 50mm

Cladding 16mm x 125mm

OPTIONS AVAILABLE

22mm premier cladding

19mm Log Lap cladding

22mm floorboards

Side fixed windows

2' veranda (with or without) please specify

Mirror image available

Felt options

Tanalised Timber

50mm x 50mm Framing



Candy Cabin



STANDARD FEATURES

- Stable door with diamond in the top
- Antique hinges and handle with adjustable closing catch
- 2 acrylic Georgian windows
- 1 window box
- Internal bunk bed with safety rail, ladder with hand rail (as pictured)
- Profiled fascias
- Roof overhang 1' / 305mm

SPECIFICATION

- sizes: 1.83m x 2.44m (6' x 8') and 2.44m x 2.44m (8' x 8')
- Eaves height 56" / 1435mm to 70" / 1785mm
- Ridge height 93" / 2360mm
- Stable door:

- Top 678mm x 596mm
- Bottom 730mm x 596mm
- Windows 457mm x 457mm
- Framing 38mm x 50mm
- Cladding 16mm x 125mm

OPTIONS AVAILABLE

- 22mm premier cladding
- 19mm Log Lap cladding
- 22mm floorboards
- Side fixed window
- Window box
- Mirror image available
- 2' veranda (with or without) please specify
- Felt options
- Tanalised Timber
- 50mm x 50mm Framing



The Hideaway



STANDARD FEATURES

- Single and double garage doors with diamond windows, complete with antique hinges and handles
- 2 acrylic Georgian windows
- 2 window boxes
- Internal bunk bed with safety rail, ladder and hand rail (as pictured)
- Profiled fascias
- Roof overhang 1' / 305mm

SPECIFICATION

- sizes: 1.52m x 3.05m (5' x 10')
- and 1.83m x 3.05m (6' x 10')
- Eaves height 56" / 1435mm to 70" / 1785mm
- Ridge height 96" / 2430mm
- Single door 1410mm x 596mm

- Double door 1042mm x 1158mm
- Windows 457mm x 457mm
- Framing 38mm x 50mm
- Cladding 16mm x 125mm

OPTIONS AVAILABLE

- 22mm premier cladding
- 19mm Log Lap cladding
- 22mm floorboards
- Additional side windows
- Mirror image available
- Felt options
- Tanalised Timber
- 50mm x 50mm Framing



Charleys Castle



STANDARD FEATURES

- Door with antique hinges, handle and adjustable door catch
- Diamond window in door
- 3 front acrylic Georgian windows
- 1 side acrylic Georgian window
- Profiled fascias and veranda boards
- 2'6" veranda with front returns
- Internal bunk bed with safety rail, ladder and hand rail (as pictured)

SPECIFICATION

- Sizes: 2.59m x 3.05m (8'6" x 10') and 3.2m x 3.05m (10'6" x 10') including 2'6" verandah

- Eaves height 66" / 1680mm
- Ridge height 110" / 2810mm
- Return veranda's 1070mm
- Door 1410mm x 596mm
- Windows 457mm x 457mm
- Framing 38mm x 50mm
- Cladding 16mm x 125mm

OPTIONS AVAILABLE

- 22mm premier cladding
- 19mm Log Lap cladding
- 22mm floorboards
- Side fixed window
- Felt options
- Tanalised Timber



Kids Club House



STANDARD FEATURES

Door with antique hinges and handle with adjustable door catch
 Diamond window in door
 4 acrylic Georgian windows
 Profiled fascias and veranda boards
 3' veranda with side returns
 Functional dormer window
 Internal bunk bed with safety rail, ladder and hand rail (as pictured)

SPECIFICATION

Sizes:
 2.13m x 3.05m (7' x 10')
 2.44m x 3.05m (8' x 10')
 3.05m x 3.05m (10' x 10')
 Eaves height 66" / 1680mm
 Ridge height 110" / 2810mm

Door 1410mm x 596mm
 Windows 457mm x 457mm
 Framing 38mm x 50mm
 Cladding 16mm x 125mm

OPTIONS AVAILABLE

22mm premier cladding
 19mm Log Lap cladding
 22mm floorboards
 Side fixed windows
 Felt options
 Tanalised Timber
 50mm x 50mm Framing

QUALITY BUILT TO LAST

Approved agent, stockist and distributor for Timber Garden Buildings Limited.

All contents of this brochure including photographs can only be reproduced with written permission and prior consent from Timber Garden Buildings Limited.

Timber Garden Buildings Limited
Unit 2 Chesterton Road
Eastwood Trading Estate
Rotherham
South Yorkshire
S65 1SU

info@tgbsheds.com
www.tgbsheds.com

